

# Operating manual

## Noise Monitoring Terminal **HD2011NMT**



Companies / Brands of GHM

Members of GHM GROUP

**GREISINGER**

**HONSBURG**

**Martens**

**IMTRON**

**Delta OHM**

[www.deltaohm.com](http://www.deltaohm.com)

**Keep for future reference.**

# INDEX

<b>1</b>	<b>INTRODUCTION</b> .....	<b>3</b>
<b>2</b>	<b>DESCRIPTION</b> .....	<b>4</b>
<b>3</b>	<b>TECHNICAL CHARACTERISTICS</b> .....	<b>6</b>
<b>4</b>	<b>INSTALLATION</b> .....	<b>7</b>
4.1	INSTALLATION OF THE HD2005.20.1 TRIPOD .....	8
4.2	FIXING THE HOUSING (MODELS HD2011NMT-BXX) TO THE MAST OR TRIPOD.....	9
4.3	INSTALLATION OF THE SOLAR PANEL (MODELS HD2011NMT-xxP).....	9
4.4	POSITIONING THE MICROPHONE UNIT .....	10
4.5	CONNECTIONS .....	11
4.6	POSITIONING THE 3G ANTENNA.....	12
4.7	INSERTING THE SIM CARD.....	13
<b>5</b>	<b>MEASUREMENTS</b> .....	<b>15</b>
<b>6</b>	<b>ALARMS</b> .....	<b>17</b>
<b>7</b>	<b>STORAGE OF INSTRUMENTS</b> .....	<b>18</b>
<b>8</b>	<b>SAFETY INSTRUCTIONS</b> .....	<b>18</b>
<b>9</b>	<b>ORDERING CODES</b> .....	<b>19</b>

# 1 INTRODUCTION

**HD2011NMT** is a Station/Terminal for long-term monitoring of environmental noise, suitable for unattended, semi-permanent and permanent installations in external environment.

Both air noise and noise from the ground can be analyzed. Measurements are performed by using a sound level meter complying with Class 1 or 2 specifications according to IEC 61672, that may include spectral and statistical analysis.

The sound measurements can optionally be matched with meteorological parameters (temperature, relative humidity, rainfall, wind speed). The RS485 interface with Master MODBUS-RTU protocol (available only with the METEO option) allows connecting an external weather station.

Various models are available, either battery powered, allowing uninterrupted measurements up to 48 hours or 7 days, or powered by a photovoltaic panel or a 24 V<sub>DC</sub> source.

The models powered by a photovoltaic panel or a 24 V<sub>DC</sub> source include a lead-acid rechargeable backup battery and a battery charger.

The power consumption of the station is optimized by powering the various components (sound level meter, modem, ...) only when it is necessary to carry out the measurements or transmit the data, so as to considerably prolong the life of the battery.

The station can be remotely controlled via the "Monitor" module of the Noise Studio program. The program, installable on any PC with a Windows® operating system, allows you to configure all the measurement parameters and the data storage and displays the measurements in graphic and tabular form. Besides, the program can configure the station to provide a real-time view of the measurements.

The internal 3G modem has the task to transfer the measurements from the internal memory to the Cloud. Each station has sufficient storage space for a session duration of at least one week. If more storage space is needed, the user can purchase additional storage space on the Delta OHM Storage Server or use an FTP server of his choice.

The client/server configuration of the station allows managing noise monitoring terminal networks using the "Monitor" module of Noise Studio software.

Alarm **e-mails** can be sent to up to 4 recipients when the set measuring thresholds are exceeded, when the battery charge level is becoming low or when the storage space is becoming full. A potential-free contact isolated alarm output is available.

The station can be provided with IP 65 box equipped with key lock or IP 67 suitcase with pressure equalization valve and closure for padlock.

## 2 DESCRIPTION

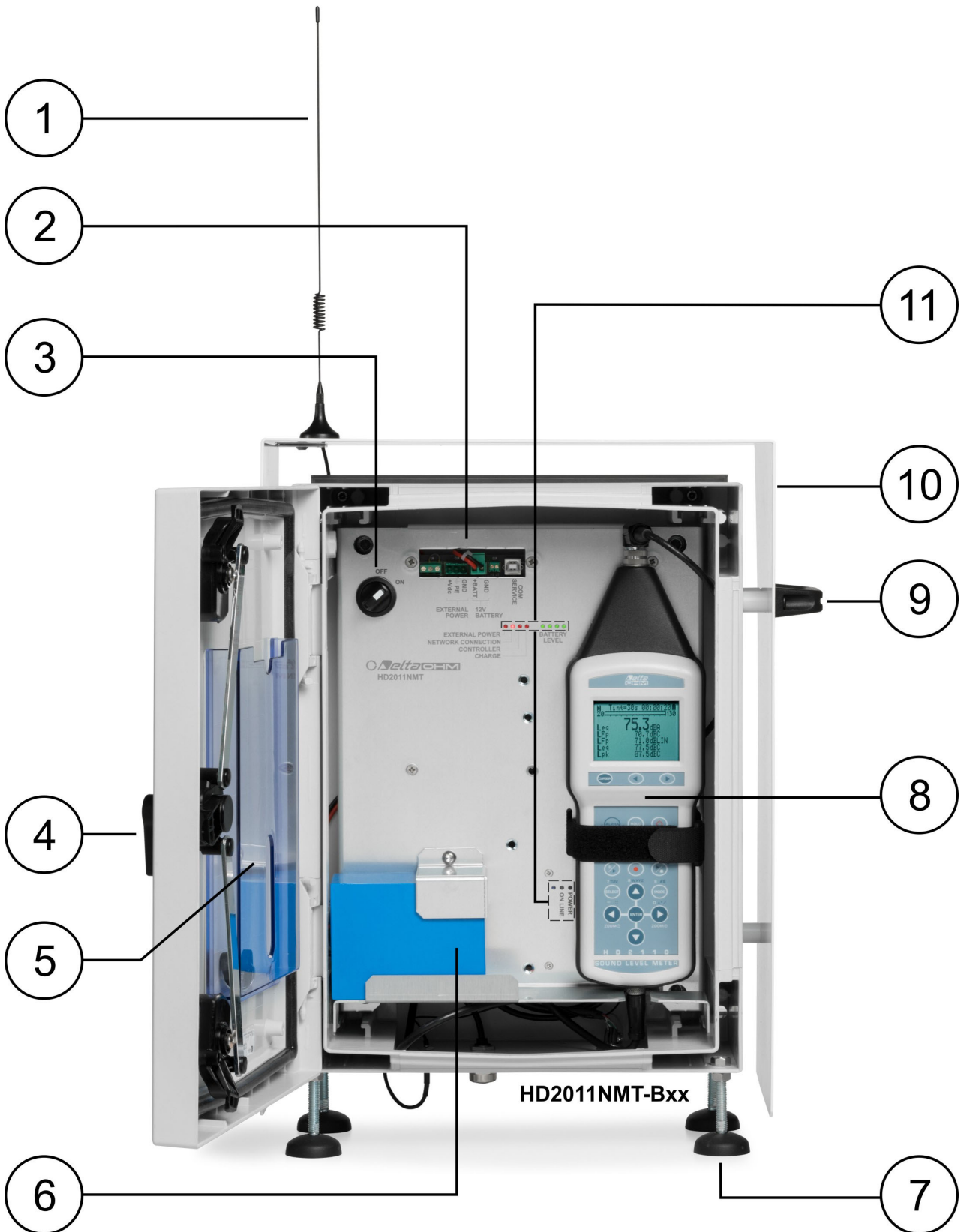

1. Antenna.
2. Terminal block.
3. ON/OFF switch.
4. Handle with key lock.
5. Documents holder.
6. Battery.
7. Feet.
8. Sound Level Meter.
9. Handle for transport.
10. Solar radiations shield.
11. LEDs:
  - **EXTERNAL POWER** LED: indicates the presence of the external power supply (solar panel or 24 V<sub>DC</sub> source).
  - **NETWORK CONNECTION** LED: lights up at the end of the functional check and the initial automatic configuration with the server after switching on the station. If it remains off after the initial phase, it means there are network problems or the station has not been recognized by the server.
  - **CONTROLLER** LED: lights up at the end of the functional check after switching on the station, to indicate that the electronics controlling the station is operational.
  - **CHARGE** LED: indicates that the battery is being charged.
  - **BATTERY LEVEL** LEDs: indicate the battery charge level.
    - All LEDs off: low battery
    - 1 LED on: charge is less than 25%
    - 2 LEDs on: charge is between 25% and 50%
    - 3 LEDs on: charge is between 50% and 75%
    - 4 LEDs on: charge is more than 75%
  - **POWER** LED: indicates the presence of the internal power supply (12 V<sub>DC</sub> of the battery).
  - **ACTIVITY** LED: blinks during the communication with the server; it is off when the station is not communicating.
  - **ON LINE** LED: indicates the presence of the connection with the server via the internal modem. If it is off, it means there are network problems.

At the bottom of the housing there are the connections for the antenna, the microphone unit, the external power supply (only for models with power supply from solar panel or 24 V<sub>DC</sub> source) any other optional external devices (meteorological sensors, alarm indicators, ...).

### 3 TECHNICAL CHARACTERISTICS

<b>Power supply</b>	12 V lithium battery for models HD2011NMT-xx <b>B</b> Solar panel or 24 V <sub>DC</sub> power supply for models HD2011NMT-xx <b>P</b>
<b>Internal battery</b>	12 V LiFePO <sub>4</sub> for models HD2011NMT-xx <b>B</b> . Batteries with 48 hours or 7 days autonomy are available. 12 V lead-acid for models HD2011NMT-xx <b>P</b> . 18 Ah (for 24 V <sub>DC</sub> power supply) or 55/70/100 Ah (for power supply from a solar panel) batteries are available. For power supply from a solar panel, as an alternative to the 45 Ah battery a 10 A UPS unit can be requested.
<b>Recording</b>	Continuous, single or at intervals with duration configurable from 5 min to 1 week
<b>Capacity of internal memory</b>	At least 24 hours of data
<b>Inputs of sensors</b>	Input for external microphone unit <i>Only for models with Meteo option (HD2011NMT-x<b>Mx</b>):</i> Input for the connection of a combined relative humidity and temperature probe, of a rain gauge and of an anemometer RS485 port with Master MODBUS-RTU protocol for the connection of an external weather station
<b>Connection to PC</b>	3G/GPRS TCP/IP connection via the 3G/GSM modem
<b>Alarms</b>	1 potential-free contact isolated alarm output. Normally open contact, max 300 mA @ 30 Vdc resistive charge. Sending of alarms via e-mail.
<b>Operational conditions</b>	-20 ... 50 °C 0 ... 85% RH non-condensing for models HD2011NMT- <b>Bxx</b> 0 ... 100% RH for models HD2011NMT- <b>Sxx</b>
<b>Storage temperature</b>	-25 ... 65 °C
<b>Materials</b>	<i>Models HD2011NMT-<b>Bxx</b>:</i> Hot-pressed fiber glass reinforced polyester case. Protection shield against solar radiation in powder-coated anodized aluminum. <i>Models HD2011NMT-<b>Sxx</b>:</i> Polypropylene suitcase with sealing gasket.
<b>Housing dimensions</b>	500x420x210 mm (solar radiations shield, handles and feet included) for models HD2011NMT- <b>Bxx</b>
<b>Weight</b>	8.9 kg approx. (sound level meter and 48 hours battery included) for models HD2011NMT- <b>Bxx</b>
<b>Housing protection degree</b>	IP 65 (models HD2011NMT- <b>Bxx</b> ) IP 67 (models HD2011NMT- <b>Sxx</b> )

## 4 INSTALLATION

The box can be placed on the floor, on the four support feet, or fixed to a wall or 36 ÷ 52 mm diameter mast.

To install the station, proceed as follows:

- In the case of a fixed installation on a mast/tripod, place the mast/tripod in the installation site. For mounting the HD2005.20.1 tripod, see par. 4.1. If the mast/tripod is rather high, bracing is advisable (HD2003.74, HD2003.75K and HD2003.78K optional accessories are available).
- Fix the supports of the housing to the wall or mast/tripod (in the case of a fixed installation) and hook the housing to the supports (see par. 4.2).
- In the case of power supply from a solar panel, install the panel (see par. 4.3).
- Screw the microphone unit on the VTRAP4M extensible stand, in the case of mobile installation, or on the top of the mast/tripod, in the case of fixed installation (see par. 4.4).
- Place the 3G antenna on the housing (see par. 4.6).
- Connect the antenna, the microphone unit, the external power supply (only for models with power supply from solar panel or 24 V<sub>DC</sub> source) any other optional external devices (meteorological sensors, alarm indicators, ...). For the connections see par. 4.5.
- Insert the SIM and configure the APN as described in par. 4.7.
- Set the sound level meter serial in RS232 mode and baud rate 115200 (see the instructions of the sound level meter).
- The station can be switched on and off by using the ON/OFF switch. After switching on, wait for the functional check and the initial automatic configuration with the server to be completed. During the functional check, the sound level meter is switched on for a couple of minutes and then switched off after the server has recognized the station. At the end, the NETWORK CONNECTION LED must light up. If the sound level meter remains on and the NETWORK CONNECTION LED remains off after the initial phase, it means there are network problems or the station has not been recognized by the server.

### CONFIGURATION OF THE STATION:

After the station is operational and connected to the network, all the operating parameters of the station can be configured via PC by using the "Monitor" module (operating with a hardware key) of the Noise Studio software. For the details on the configuration of the station, please see the instructions of the software.

The "Monitor" module allows managing either a single station or networks of noise monitoring terminals.

The measurements can be stored in folders ordered by date, in a reserved area on the Delta OHM Storage Server or on any other FTP server. The HD2011NMT station sends periodically the measurements to the user-selected storage area. Measurement files can be viewed with the "Monitor" module and analyzed with the other Noise Studio application modules.

The interval with which the station sends the data (default 5 minutes) can be changed, as well as with the "Monitor" module of the Noise Studio software, also by sending to

the phone number of the SIM inserted in the station an SMS with the following text:

**<password; RDLWT=interval;reset>**

With: *password* = last 6 digits of the sound level meter serial number.  
*interval* = data transmission interval in seconds (minimum 30).

Example: <256155; RDLWT=60;reset>

After sending the SMS, the station must be switched off and back on with the ON/OFF switch.

#### 4.1 INSTALLATION OF THE HD2005.20.1 TRIPOD

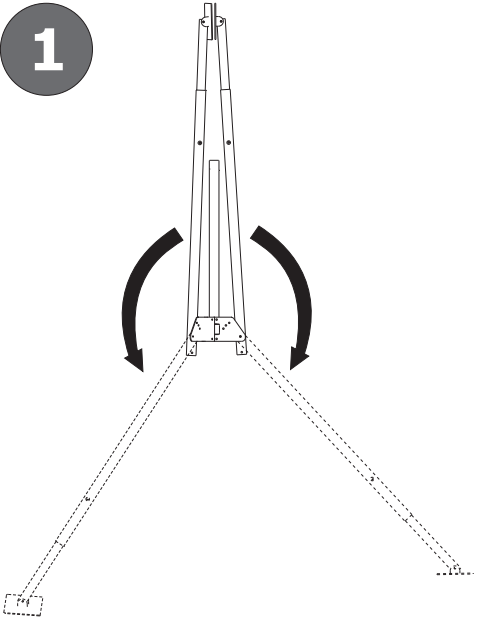
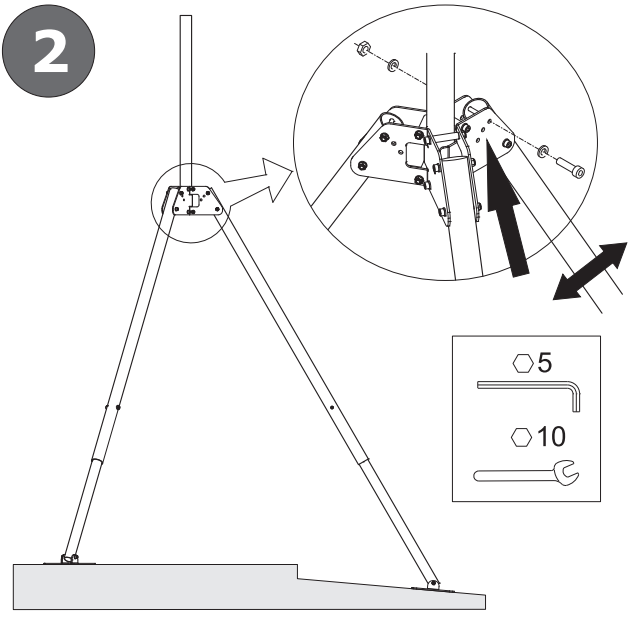
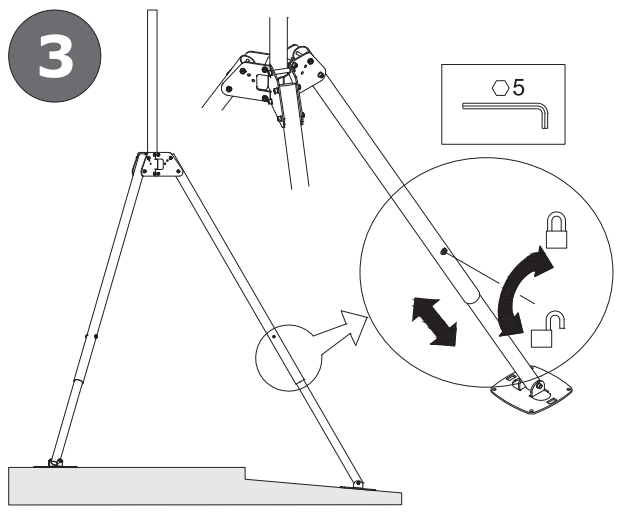
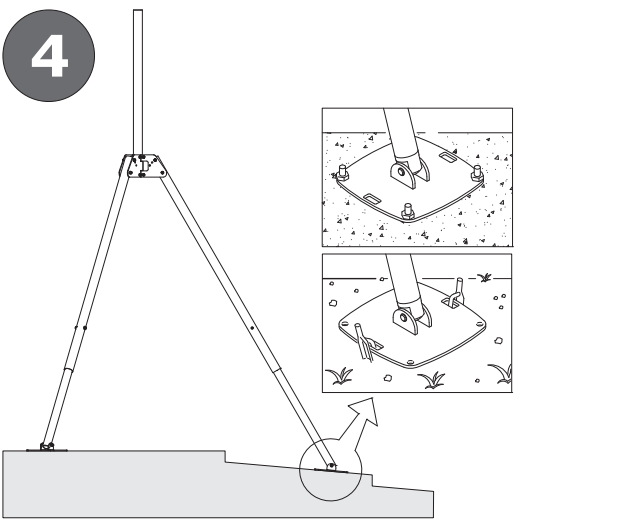
<p><b>1</b></p>  <p>Pull out the tripod from the bag and open it by turning the three legs.</p>	<p><b>2</b></p>  <p>Secure the legs to the central block of the tripod. The inclination of the legs can be adjusted using the various holes available.</p>
<p><b>3</b></p>  <p>Adjust the height of the legs and tighten the locking screw.</p>	<p><b>4</b></p>  <p>The flanges of the tripod can be fixed on a floor with screws or on the ground with pegs.</p>



## 4.2 FIXING THE HOUSING (MODELS HD2011NMT-BXX) TO THE MAST OR TRIPOD

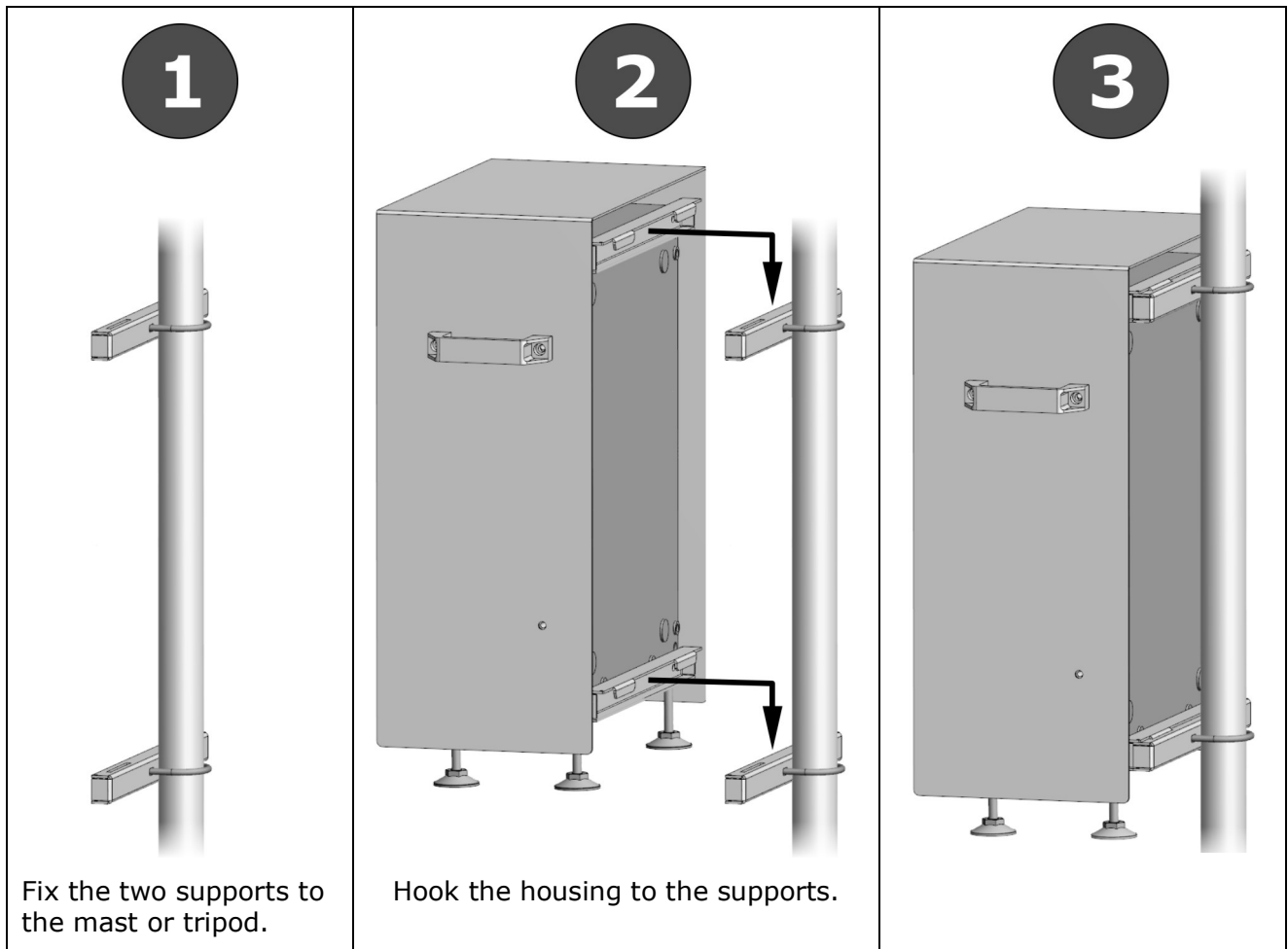

## 4.3 INSTALLATION OF THE SOLAR PANEL (MODELS HD2011NMT-xxP)

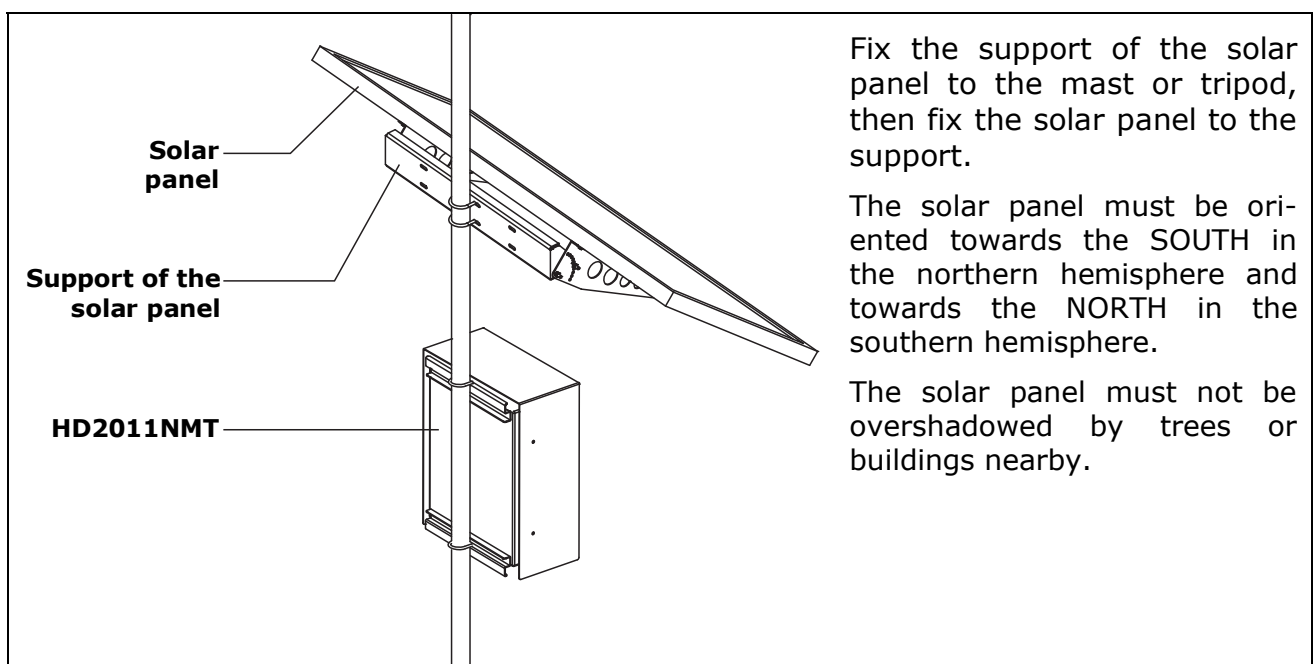

#### 4.4 POSITIONING THE MICROPHONE UNIT

---

The microphone unit can be screwed on the **VTRAP4M** extensible stand, for mobile installations, or on the top of the mast or **HD2005.20.1** tripod, for fixed installations. Pass the connecting cable inside the tube.

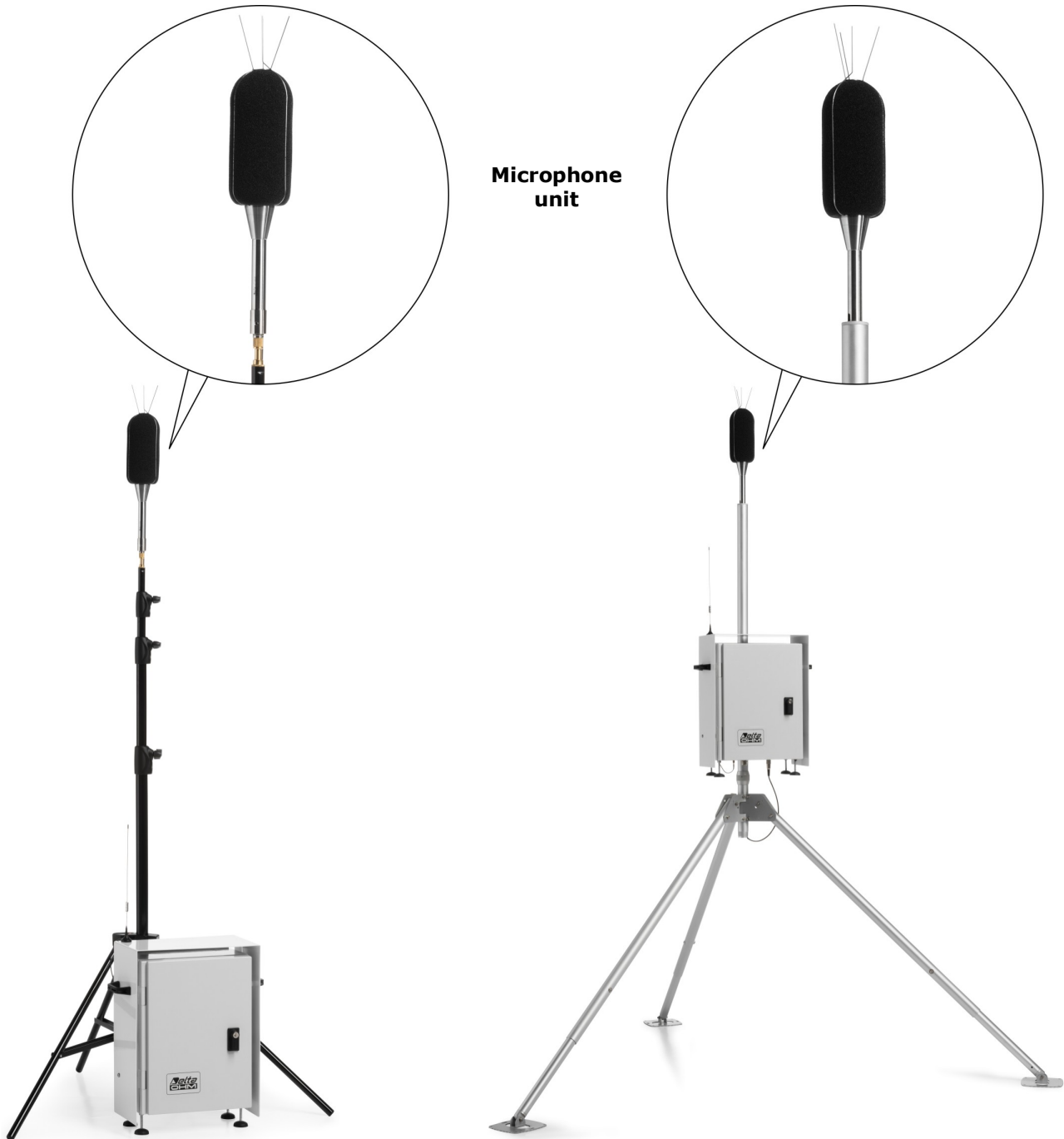

**Mobile installation with box placed on the floor and microphone unit placed on the extensible VTRAP4M stand**

**Fixed installation with HD2005.20.1 tripod**

The **VTRAP4M** stand is extensible and transportable; it has 3.7 m maximum height for positioning the microphone at 4 m height. The **HD2005.20.1** tripod has 3 m maximum height, extensible to 4 m with optional HD2003.72.AA extension.

## 4.5 CONNECTIONS

The external components of the station (antenna, microphone unit, solar panel or 24 V<sub>DC</sub> source, any meteorological sensors, alarm indicators, ...) are connected via the inputs/outputs at the bottom of the housing.

The inputs/outputs layout can vary depending on the options available in the station. The function of each connector is clearly indicated by the label located near the connector itself.

All the models have the input for the antenna and the input for the microphone unit.

The models powered by a lithium battery have a connector for connecting the charger. The connector can be located at the bottom of the housing (BATTERY CHARGER label) or inside the housing depending on the type of battery used. The following image shows the inputs layout in a model without optional inputs/outputs and powered by a lithium battery with 48h autonomy.

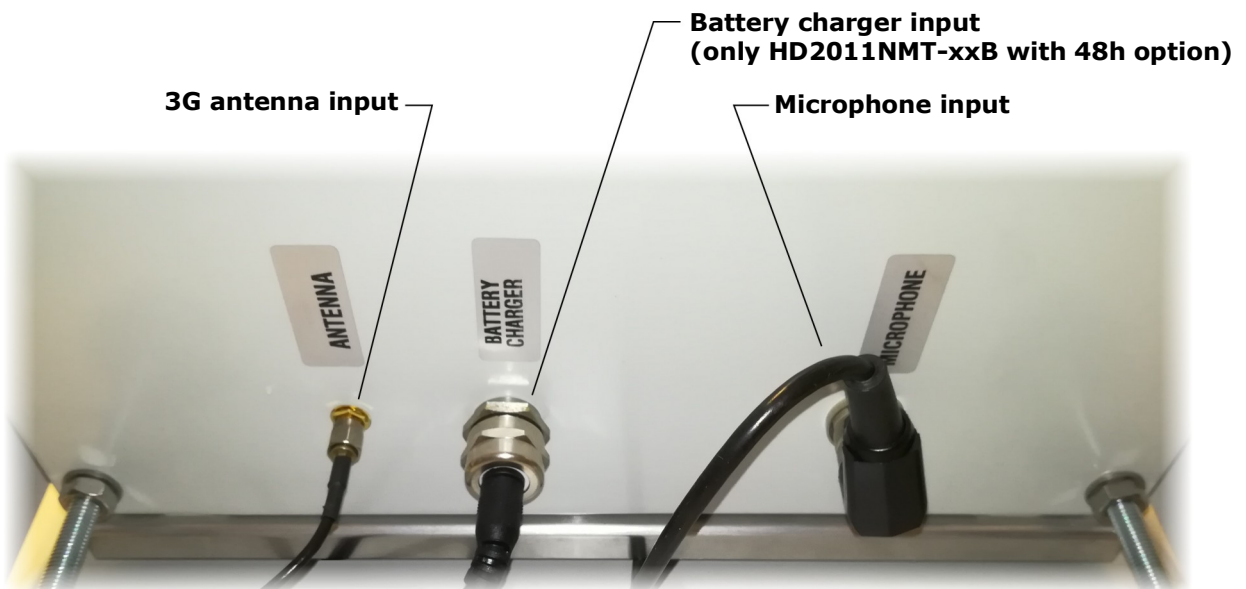

In the models powered by a solar panel or 24 V<sub>DC</sub> source, pass the power cable through the cable gland at the bottom of the housing, then connect the cable to the terminals EXTERNAL POWER of the internal terminal block.

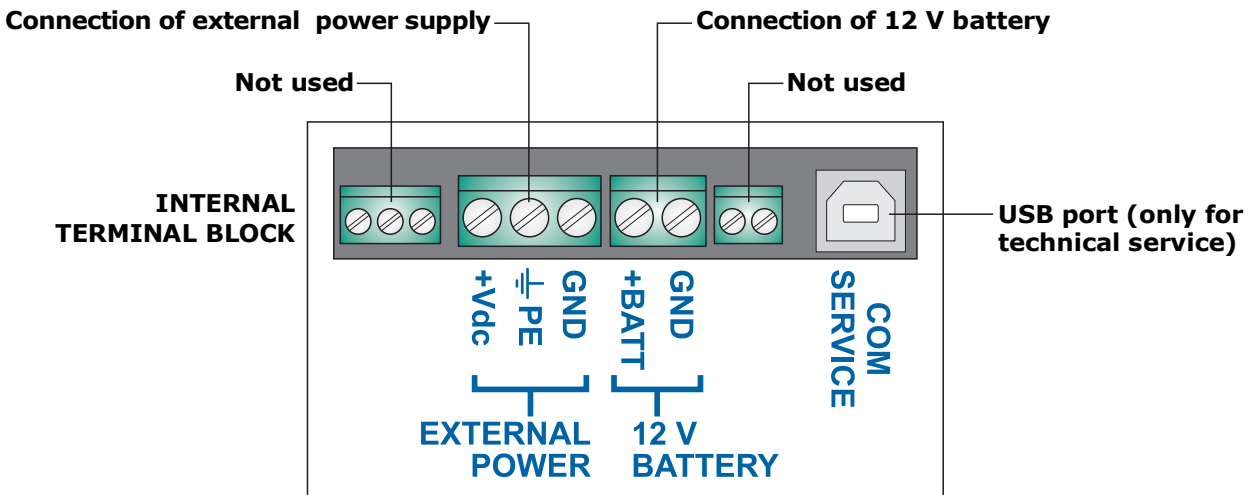

**ELECTRICAL SAFETY:**

**Ensure a good protective earth connection of the station. At the bottom of the housing there is a terminal for the protective earth connection.**

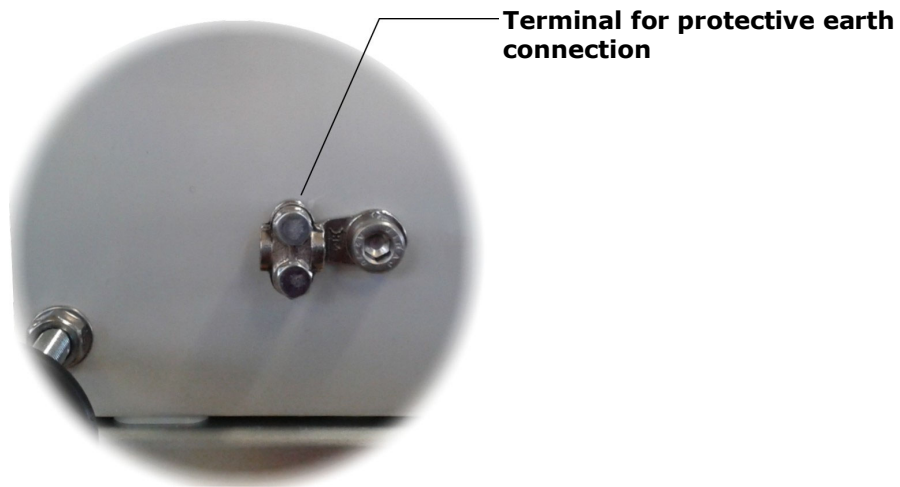

**In case of fixed installation on a mast or tripod, install a lightning rod on the top of the mast or tripod. The lightning rod must be electrically insulated from the mast/tripod and must be properly connected to ground rods.**

**4.6 POSITIONING THE 3G ANTENNA**

---

Place the 3G antenna on top of the housing protection shield. A metal plate is positioned under the upper and back left corner of the shield, in order to hold the magnetic base of the antenna in place.

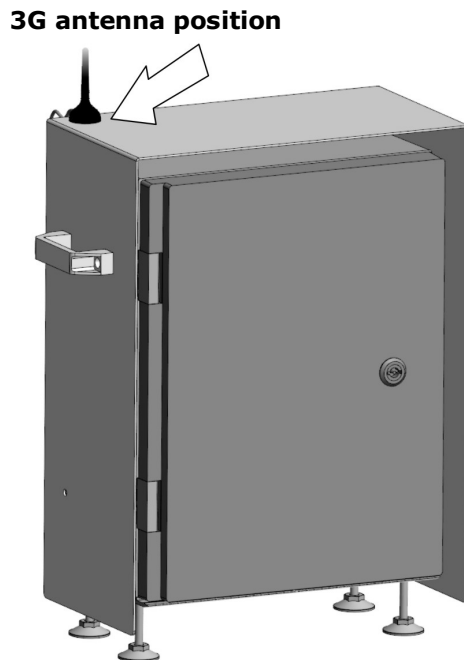

## 4.7 INSERTING THE SIM CARD

---

In order to use the 3G/GSM functionalities of the station, a **SIM** card enabled for data transmission must be inserted into the internal modem. The card should be requested to a carrier that has an adequate coverage of the 3G/GSM network in the place where the station will be installed. To insert the card, proceed as follows.

1. Switch off the station (ON/OFF switch to OFF).
2. Open the Velcro strap that tightens the sound level meter and remove the sound level meter.



3. After removing the sound level meter, the opening to access the modem is visible. The modem is located on the left side of the opening.

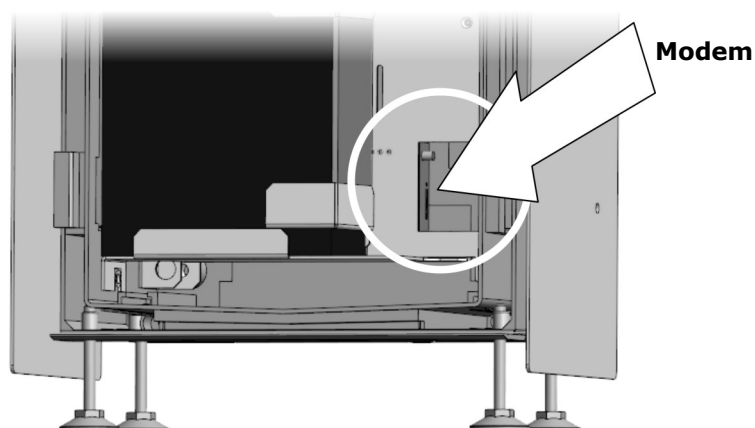

4. Press, with a pointed object, the release button of the SIM tray and extract the tray. Insert the SIM card into its tray (the SIM card contacts must face the outside of the tray, the tray is provided with an insertion key that prevents the possibility of inserting the SIM card improperly) and put the SIM tray back in place.

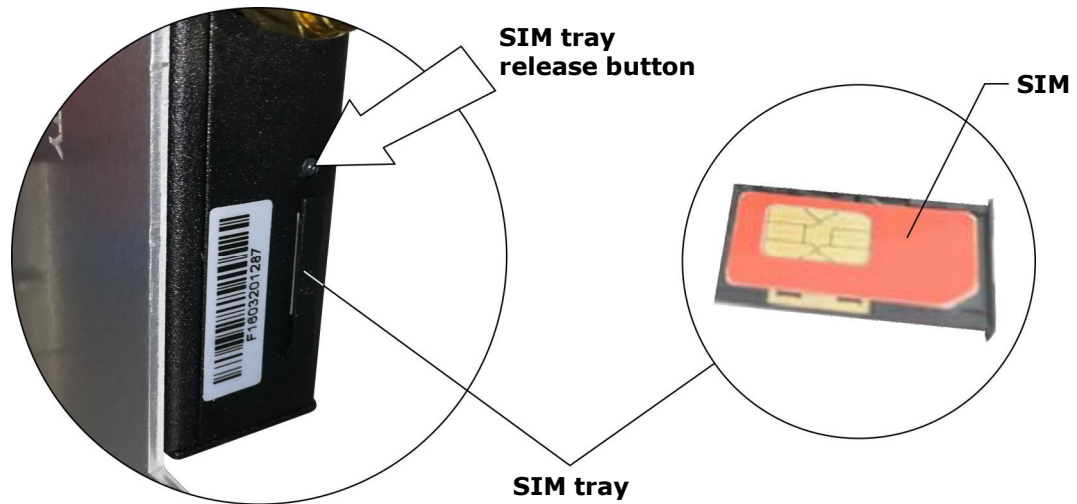

5. Put the sound level meter back in place and tighten the velcro strap.

#### **APN CONFIGURATION:**

After inserting the SIM, it is necessary to configure the APN (Access Point Name) for the access to the network:

1. Switch on the station (ON/OFF switch to ON).
2. Send to the phone number of the SIM inserted in the station an SMS with the following text:

**<password;APN=name;reset>**

With: *password* = last 6 digits of the modem serial number.  
*name* = name of the APN provided by the phone operator.

Example: <256155;APN=internet.operator;reset>

3. Switch the station off and back on with the ON/OFF switch.

## 5 MEASUREMENTS

The following table shows the available sound level meter measurement parameters.

	REAL TIME	INTEGRATION TIME	PARAMETERS	
<b>TIME HISTORY</b>	No	1/32 s	1 "Short" L <sub>x,eq</sub>	x = A, C or Z
	Yes	1/8 s	1 selectable <sup>1</sup> parameter: <ul style="list-style-type: none"> <li>• L<sub>xyp</sub></li> <li>• L<sub>xpk</sub></li> <li>• "short" L<sub>x,eq</sub></li> </ul> 1) Only LAFp for HD2010UC and HD2010UC/A	x = A, C or Z; y = F, S or I x = A or C x = A, C or Z
	Yes	1/2 s	5 selectable parameters: (3 for HD2010UC and HD2010UC/A): <ul style="list-style-type: none"> <li>• L<sub>xyp</sub></li> <li>• L<sub>xpk</sub></li> <li>• "short" L<sub>x,eq</sub></li> <li>• L<sub>x,eq</sub></li> </ul>	x = A, C or Z; y = F, S or I x = A or C x = A, C or Z x = A, C or Z
	Yes		Third octave spectrum 16 Hz ÷ 20 kHz (25 Hz ÷ 12.5 kHz for HD2010UC and HD2010UC/A)	Weighting LIN, FAST or SLOW
<b>REPORTS</b>	No	1s ÷ 1h	5 selectable parameters: <ul style="list-style-type: none"> <li>• L<sub>xyp,max</sub></li> <li>• L<sub>xyp,min</sub></li> <li>• L<sub>xpk,max</sub></li> <li>• L<sub>xpk,min</sub></li> <li>• L<sub>x,eq</sub></li> <li>• L1 ÷ L4</li> <li>• Overload</li> </ul>	x = A, C or Z; y = F, S or I x = A, C or Z; y = F, S or I x = A or C x = A or C x = A, C or Z 1% ÷ 99%
	No		Third octave spectrum 16 Hz ÷ 20 kHz (25 Hz ÷ 12.5 kHz for HD2010UC and HD2010UC/A)	Weighting LIN
	No		Statistics distribution	
<b>EVENTS</b>	No	Event duration	5 selectable parameters: <ul style="list-style-type: none"> <li>• L<sub>xyp,max</sub></li> <li>• L<sub>xyp,min</sub></li> <li>• L<sub>xpk,max</sub></li> <li>• L<sub>xpk,min</sub></li> <li>• L<sub>x,eq</sub></li> <li>• L1 ÷ L4</li> <li>• Overload</li> </ul>	x = A, C or Z; y = F, S or I x = A, C or Z; y = F, S or I x = A or C x = A or C x = A, C or Z 1% ÷ 99%
	No		Third octave spectrum 16 Hz ÷ 20 kHz (25 Hz ÷ 12.5 kHz for HD2010UC and HD2010UC/A)	Weighting LIN
	No		Statistics distribution	

The choice of the measurements to be acquired and acquisition mode is carried out with the help of Noise Studio software (see the instructions of the software for details).

The acquisition of sound level parameters can be:

- **Continuous:** manual Start and Stop of the acquisition.
- **Single:** the acquisition starts at the programmed date and time and lasts for the set duration.
- **At intervals:** the acquisition starts at the programmed date and time, lasts for the set duration and is repeated at regular intervals.

In addition to the measurements acquisition, an automatic calibration to be carried out at the beginning and/or at the end of the acquisition or to be carried out at regular intervals can be programmed.



## 6 ALARMS

The data logger can report:

- the exceeding of the measurement thresholds defined by the user;
- the decrease of the battery charge level below certain thresholds (75%, 50% and 25%);
- the excessive memory usage on the server (greater than 50% or 75% of available space).

With regard to the measurement alarms, the following are available:

- an alarm for an acoustic measurement downloaded on the server (the generation of this alarm depends on when the measurements are downloaded);
- an alarm for a real time acoustic measurement;
- an alarm that can be associated with one of the available environmental parameters (only with METEO option).

It is possible to configure how long the measurement must remain above the set threshold before generating the alarm and how long the measurement must remain within the deactivation threshold before turning off the alarm.

The alarm can be reported by activating the alarm output (only for the exceeding of the measurement thresholds) and/or sending e-mails, up to 4 recipients, with user configurable text.

The alarm contact can be configured as normally open or normally closed.

The choice of the measurements to be associated with the alarms and the configuration of the alarms is carried out with the help of Noise Studio software (see the instructions of the software for details).

## 7 STORAGE OF INSTRUMENTS

Storage conditions of the instruments:

- Temperature: -25...+65 °C.
- Humidity: less than 90 %RH no condensation.
- For storage, avoid places where:
  - There is a high level of humidity;
  - Instruments are exposed to direct sun radiation;
  - Instruments are exposed to a high temperature source;
  - There are strong vibrations;
  - There is vapor, salt and/or corrosive gases.

## 8 SAFETY INSTRUCTIONS

### General instructions for safety

These instruments have been manufactured and tested in compliance with the safety standards EN61010-1:2010 for electronic instruments of measure and left the factory in perfect safety technical conditions.

The regular functioning and operational safety of these instruments can be ensured only if all normal safety measures, as well as the specific measures described in this manual, are followed.

The regular functioning and operational safety of the instruments can only be guaranteed under the climatic conditions specified in the manual.

Do not use the instruments in places where there are:

- Rapid ambient temperature variations that may cause condensation.
- Corrosive or flammable gases.
- Direct vibrations or bumps to the instrument.
- High-intensity electromagnetic fields, static electricity.

If instruments are transported from a cold environment to a warm one, or vice versa, the formation of condensation may cause disturbances to their functioning. In this case, wait until the temperature of the instrument reaches room temperature before putting into operation.

### Obligations of the User

The user of the instruments must ensure compliance with the following standards and guidelines for the treatment of hazardous materials:

- EEC directives on workplace safety
- National low regulations on workplace safety
- Accident prevention regulations

## 9 ORDERING CODES

**HD2011NMT-...** Station/Terminal for long-term monitoring of environmental noise. With 3G/GSM modem for data transmission to the Cloud. One alarm output and sending of alarms via e-mail. Power supply: battery or external from solar panel or 24 V<sub>DC</sub> source depending on the model. IP 65 or IP 67 housing depending on the model. Option for measuring meteorological parameters (temperature, relative humidity, rainfall, wind speed) is available. The operation of the station requires the **NS4** "Monitor" software module.

**The sound level meter, the outdoor microphone chain, the meteorological sensors, the 12 V battery, the NS4 "Monitor" module of Noise Studio software, the tripod and the fixing accessories have to be specified separately. The SIM card is not included.**

**The microphone must be compatible with HD2010PNE2W (if HD2010UC or HD2010UC/A sound level meter is ordered) or HD2110PEWL (if HD2110L sound level meter is ordered) pre-amplifier.**

**For the models HD2011NMT-xxB, please specify when ordering if you need the battery with 48 hours (HD2011-Li9A) or 7 days (HD2011-Li40A) autonomy.**

**For the models HD2011NMT-xxP, please specify when ordering if you need the 18 Ah (HD2011-Pb18A), 55 Ah (HD2011-Pb55A), 70 Ah (HD2011-Pb70A) o 100 Ah (HD2011-Pb100A) battery.**

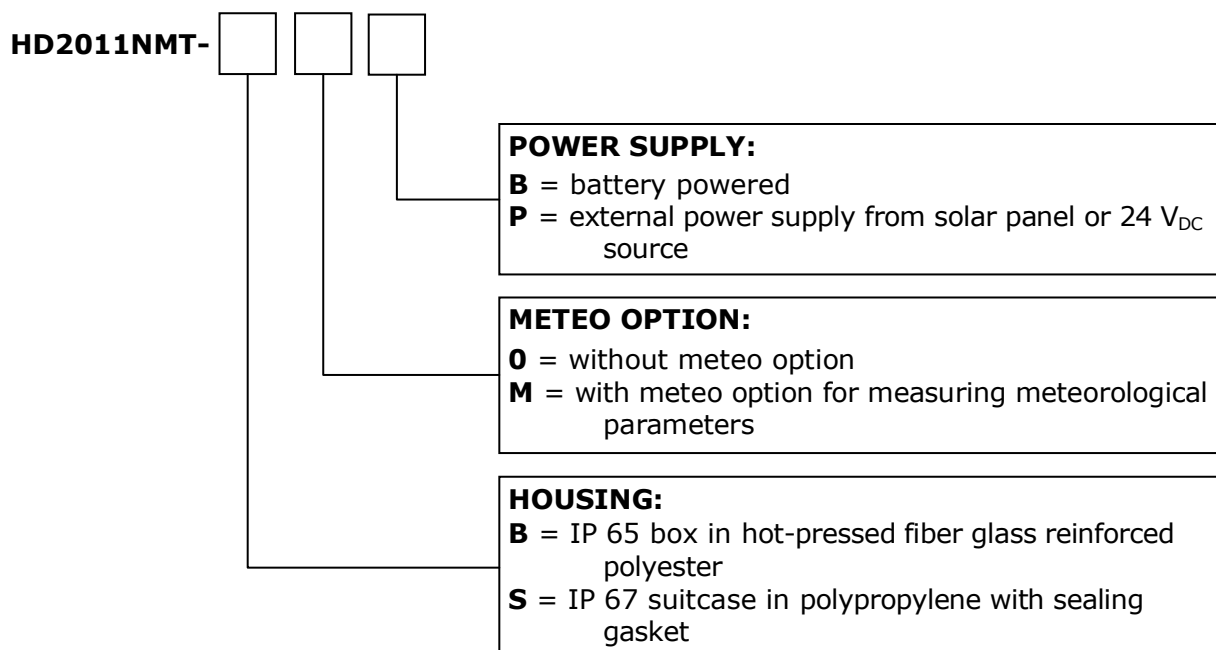

## Sound level meters that can be combined with the HD2011NMT station

---

- HD2010UC** Integrating sound level meter and statistical analyzer.
- Compliance certificate: class1 according to IEC 61672:2002
  - Class: 1 or 2 according to IEC 61672:2002
  - Dynamic range: 30 dB ÷ 140 dB
  - Linear range: 80 dB
  - Pre-amplifier: HD2010PNE2W
- Required options:**
- **Advanced Data logger** : sound level profiles, statistical analysis, capture and analysis of sound events.
  - **Memory expansion** : doubles the memory capacity.
  - **Monitor** : continuous data-logging, power supply via serial cable; specific for operating with HD2011NMT monitoring stations.
- HD2010UC/A** Integrating sound level meter, statistical and spectrum analyzer.
- Compliance certificate: class1 according to IEC 61672:2002
  - Class: 1 or 2 according to IEC 61672:2002 and class 1 according to IEC 61260
  - Dynamic range: 30 dB ÷ 140 dB
  - Linear range: 80 dB
  - Spectral analysis by octave bands from 32 Hz to 8 kHz and (optionally) third octave bands from 25 Hz to 12.5 kHz
  - Pre-amplifier: HD2010PNE2W
- Required options:**
- **Memory expansion** : doubles the memory capacity.
  - **Monitor** : continuous data-logging, power supply via serial cable; specific for operating with HD2011NMT monitoring stations.
- Other options:**
- **Third octave** : third octave band analysis from 25 Hz to 12.5 kHz.
- HD2110L** Integrating sound level meter, statistical and spectrum analyzer.
- Compliance certificate: IEC 61672:2002
  - Class: 1 according to IEC 61672:2002 and IEC 61260
  - Dynamic range: 25 dB ÷ 140 dB
  - Linear range: 110 dB
  - Spectral analysis by octave bands from 16 Hz to 16 kHz and (optionally) third octave bands from 16 Hz to 20 kHz
  - Pre-amplifier: HD2110PEWL
- Required options:**
- **Monitor** : continuous data-logging, power supply via serial cable; specific for operating with HD2011NMT monitoring stations.
- Other options:**
- **Third octave** : third octave band analysis from 16 Hz to 20 kHz.

## Accessories

---

<b>HD2011-Li9A</b>	12 V lithium battery for 48 hours autonomy. To be mounted inside the HD2011NMT station.
<b>HD2011-Li40A</b>	12 V lithium battery for 7 days autonomy. To be mounted inside the HD2011NMT station.
<b>HD2011-Pb18A</b>	12 V / 18 Ah lead-acid battery. To be mounted inside the HD2011NMT station. For 24 V <sub>DC</sub> power supply.
<b>HD2011-Pb55A</b>	12 V / 55 Ah lead-acid battery. To be mounted outside the HD2011NMT station. For power supply from a solar panel.
<b>HD2011-Pb70A</b>	12 V / 70 Ah lead-acid battery. To be mounted outside the HD2011NMT station. For power supply from a solar panel.
<b>HD2011-Pb100A</b>	12 V / 100 Ah lead-acid battery. To be mounted outside the HD2011NMT station. For power supply from a solar panel.
<b>HD2011-V55</b>	Waterproof suitcase for transporting and positioning the HD2011-Pb55A battery (not included).
<b>HD2011-V100</b>	Waterproof suitcase for transporting and positioning the HD2011-Pb70A or HD2011-Pb100A battery (not included).
<b>HD32MT.SWD</b>	100...240 Vac / 24 Vdc supply box with switch. Suitable for fastening to a rod. Includes fastening accessories.
<b>HD2011-GPS</b>	GPS module.
<b>HD2011NMT.9</b>	Threaded bush for fixing HDWME on $\varnothing$ 40 mm mast.
<b>HD2005.20.1</b>	Tripod kit in anodized aluminum with adjustable legs for the installation of environmental sensors. Height 3 m (4 m with optional HD2003.72.AA extension).
<b>HD2003.72.AA</b>	Extension L=1 m for HD2005.20.1 tripod.
<b>VTRAP4M</b>	Aluminum stand, extensible and transportable. Maximum height 3.7 m for positioning the microphone at 4 m height. Height when closed 1.07 m. Minimum height 1.24 m. Threaded connection for HDWME. Equipped with cushioning. When used extended in conjunction with HDWME, the bracing with HD2003.75K or HD2003.78K (not included) is recommended.
<b>PFV.120W</b>	120W photovoltaic panel.
<b>HD2004.22K</b>	Kit for fastening the photovoltaic panel.
<b>HD2003.75K</b>	Kit for bracing the mast, to fix on the ground with pegs, 2 m fixing diameter.
<b>HD2003.78K</b>	Kit for bracing the mast, to fasten on the floor with screws, 2 m fixing diameter.
<b>HD2003.74</b>	Clamping with bubble level for $\varnothing$ 40 mm mast with 3 tie rods for bracing.

**Delta OHM LAT N° 124 metrology laboratories are ISO/IEC 17025 accredited by ACCREDIA in Temperature, Humidity, Pressure, Photometry/Radiometry, Acoustics and Air Speed. They can provide certificates for the accredited quantities.**

**NOTES**

---



**DICHIARAZIONE DI CONFORMITÀ UE  
EU DECLARATION OF CONFORMITY**

**Delta Ohm S.r.L. a socio unico – Via Marconi 5 – 35030 Caselle di Selvazzano – Padova – ITALY**

Documento Nr. / Mese.Anno: **5088 / 01.2018**  
Document-No. / Month.Year :

Si dichiara con la presente, in qualità di produttore e sotto la propria responsabilità esclusiva, che i seguenti prodotti sono conformi ai requisiti di protezione definiti nelle direttive del Consiglio Europeo:  
*We declare as manufacturer herewith under our sole responsibility that the following products are in compliance with the protection requirements defined in the European Council directives:*

Codice prodotto:  
*Product identifier :* **HD2011NMT**

Descrizione prodotto:  
*Product description :* **Terminale di monitoraggio acustico  
Noise Monitoring Terminal**

I prodotti sono conformi alle seguenti Direttive Europee:  
*The products conform to following European Directives:*

Direttive / Directives	
2014/30/EU	Direttiva EMC / EMC Directive
2014/35/EU	Direttiva bassa tensione / Low Voltage Directive
2011/65/EU	RoHS / RoHS

Norme armonizzate applicate o riferimento a specifiche tecniche:  
*Applied harmonized standards or mentioned technical specifications:*

Norme armonizzate / Harmonized standards	
EN 61010-1:2010	Requisiti di sicurezza elettrica / Electrical safety requirements
EN 61326-1:2013	Requisiti EMC / EMC requirements
EN 50581:2012	RoHS / RoHS

Il produttore è responsabile per la dichiarazione rilasciata da:  
*The manufacturer is responsible for the declaration released by:*

Johannes Overhues

Amministratore delegato  
*Chief Executive Officer*

Caselle di Selvazzano, 08/01/2018

Questa dichiarazione certifica l'accordo con la legislazione armonizzata menzionata, non costituisce tuttavia garanzia delle caratteristiche.  
*This declaration certifies the agreement with the harmonization legislation mentioned, contained however no warranty of characteristics.*

# GUARANTEE



Member of GHM GROUP

## TERMS OF GUARANTEE

All DELTA OHM instruments are subject to accurate testing, and are guaranteed for 24 months from the date of purchase. DELTA OHM will repair or replace free of charge the parts that, within the warranty period, shall be deemed non efficient according to its own judgement. Complete replacement is excluded and no damage claims are accepted. The DELTA OHM guarantee only covers instrument repair. The guarantee is void in case of incidental breakage during transport, negligence, misuse, connection to a different voltage than that required for the appliance by the operator. Finally, a product repaired or tampered by unauthorized third parties is excluded from the guarantee. The instrument shall be returned FREE OF SHIPMENT CHARGES to your dealer. The jurisdiction of Padua applies in any dispute.



The electrical and electronic equipment marked with this symbol cannot be disposed of in public landfills. According to the Directive 2011/65/EU, the european users of electrical and electronic equipment can return it to the dealer or manufacturer upon purchase of a new one. The illegal disposal of electrical and electronic equipment is punished with an administrative fine.

This guarantee must be sent together with the instrument to our service centre.

IMPORTANT: Guarantee is valid only if coupon has been correctly filled in all details.

**Instrument Code: HD2011NMT**

Serial Number \_\_\_\_\_

## RENEWALS

Date \_\_\_\_\_

Date \_\_\_\_\_

Inspector \_\_\_\_\_

Inspector \_\_\_\_\_

Date \_\_\_\_\_

Date \_\_\_\_\_

Inspector \_\_\_\_\_

Inspector \_\_\_\_\_

Date \_\_\_\_\_

Date \_\_\_\_\_

Inspector \_\_\_\_\_

Inspector \_\_\_\_\_





The quality level of our instruments is the result of the constant development of the product. This may produce some differences between the information written in this manual and the instrument you have purchased. We cannot completely exclude the possibility of errors in the manual, for which we apologize.

The data, images and descriptions included in this manual cannot be legally asserted. We reserve the right to make changes and corrections with no prior notice.

